

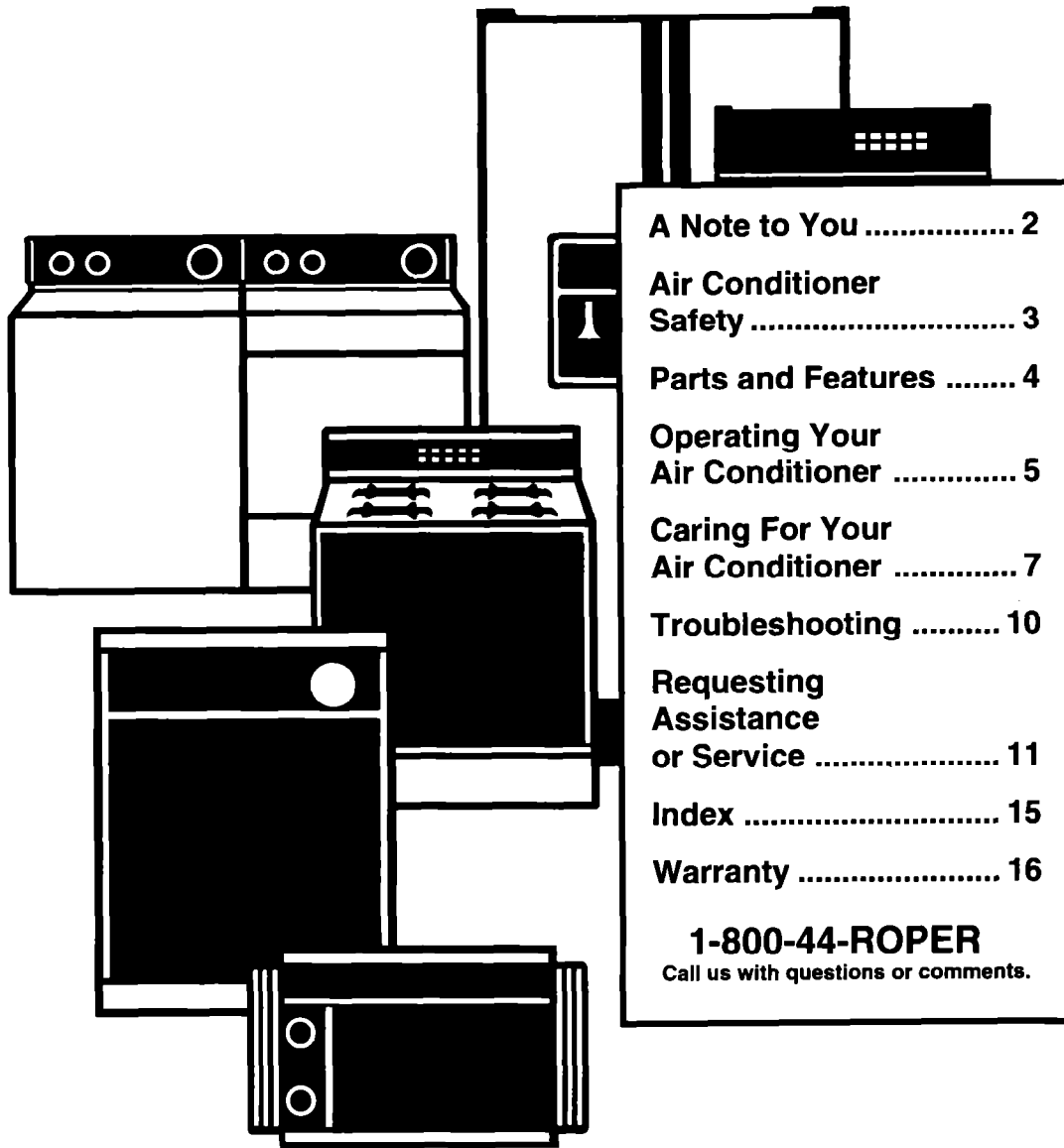

Use And Care

G U I D E



A Note to You	2
Air Conditioner Safety	3
Parts and Features	4
Operating Your Air Conditioner	5
Caring For Your Air Conditioner	7
Troubleshooting	10
Requesting Assistance or Service	11
Index	15
Warranty	16

1-800-44-ROPER
Call us with questions or comments.

AIR CONDITIONER

PART NO. 1159417 Rev. A

11/95

MODELS: X05002X0 X07002X0

A Note To You

Thank you for buying a ROPER® appliance.

ROPER appliances give you all the functionality of name brand appliances at a value price. To ensure you enjoy years of trouble-free operation, we developed this Use and Care Guide. It contains valuable information about how to operate and maintain your appliance properly and safely. Please read it carefully. Also, please complete and mail the Ownership Registration Card provided with your appliance. This card helps us notify you about any new information on your appliance.

Please record your model's information.

Whenever you call to request service on your appliance, you need to know your complete model number and serial number. You can find this information on the model and serial number label (see diagram on page 4 for location of label).

Please also record the purchase date of your appliance and your dealer's name, address, and telephone number.

Model Number _____

Serial Number _____

Purchase Date _____

Dealer Name _____

Dealer Address _____

Dealer Phone _____

Keep this book and the sales slip together in a safe place for future reference.

CALL 1-800-447-6737
WITH QUESTIONS OR COMMENTS

Air Conditioner Safety

Your safety is important to us.

This guide contains statements under warning symbols. Please pay special attention to these symbols and follow any instructions given. Here is a brief explanation of the use of the symbol.

WARNING

This symbol alerts you to such dangers as fire, electrical shock, burns, and personal injury.

IMPORTANT SAFETY INSTRUCTIONS

WARNING

To reduce the risk of fire, electrical shock, or injury when using your air conditioner, follow these basic precautions:

- Read all instructions before using the air conditioner.
- Complete the installation requirements as described in the Installation Instructions.
- Do not operate the air conditioner with the front panel removed.
- Never clean air conditioner parts with flammable fluids. The fumes can create a fire hazard or explosion.

• FOR YOUR SAFETY •

DO NOT STORE OR USE GASOLINE OR OTHER FLAMMABLE VAPORS AND LIQUIDS IN THE VICINITY OF THIS OR ANY OTHER APPLIANCE. THE FUMES CAN CREATE A FIRE HAZARD OR EXPLOSION.

– SAVE THESE INSTRUCTIONS –

Help us help you

Please:

- Install your air conditioner in a window that will hold the weight, and secure the air conditioner according to the installation instructions.
- Connect the air conditioner to the proper kind of outlet with the correct electrical supply and grounding. (See the Installation Instructions.)
- Make sure the air conditioner is the correct size for the area you want to cool.
- Use the air conditioner only to do what a window air conditioner is designed to do.

- Make sure the air conditioner is not used by anyone unable to operate it properly.
- Maintain the air conditioner properly.

Also, remove the Energy Label. Use a damp cloth to take off any glue residue. DO NOT use sharp instruments, flammable fluids, or abrasive cleaners. These can damage the material.

Parts and Features

Below are illustrations of your appliance with the parts and features called out. To help you find information on specific parts or features faster, page references are included.

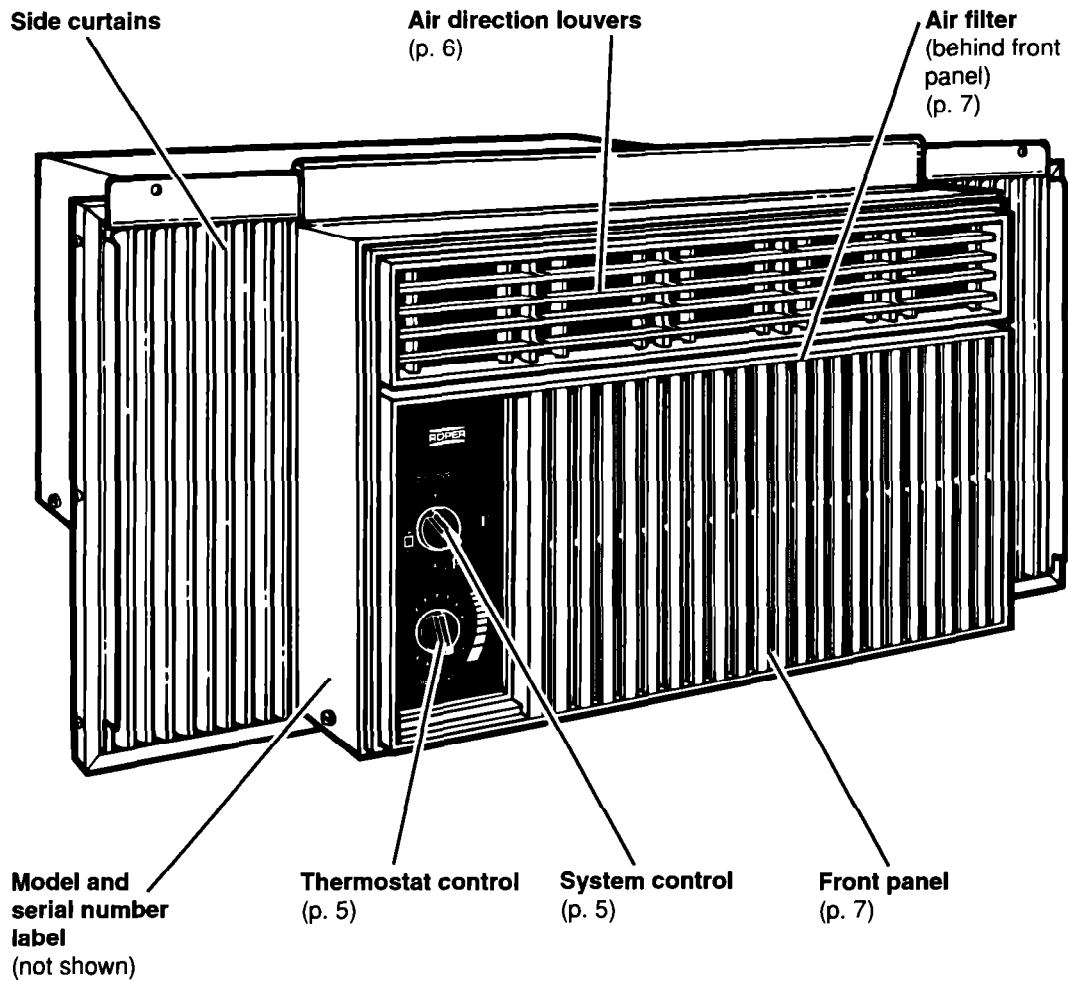

CALL 1-800-447-6737
WITH QUESTIONS OR COMMENTS

Operating Your Air Conditioner

To obtain the best possible results from your air conditioner, it is important that you operate it properly. This section tells you how to set the controls and how to direct the cooled air.

Starting your air conditioner

⚠ WARNING



Fire Hazard

Do not use an extension cord.
Doing so can result in death, fire, or electrical shock.

⚠ WARNING



Electrical Shock Hazard

Plug into a grounded 3-prong outlet.
Do not remove ground prong.
Failure to follow these instructions can result in death or electrical shock.

1. **Set the System Control** to the desired setting.
LO COOL – for sleeping comfort
HI COOL – for maximum cooling
FAN ONLY – to circulate room air without cooling it
2. **Turn the Thermostat Control** to number 6 (mid setting). You can adjust the air conditioner's cooling performance by setting the Thermostat Control to a higher number for more cooling or to a lower number for less cooling. Experiment to find the setting(s) that suits you best.

IMPORTANT: If you turn the air conditioner off, or if the compressor turns off when you lower the Thermostat Control, wait at least three minutes before turning the air conditioner back on. If you don't wait, you may blow a fuse or trip a circuit breaker.

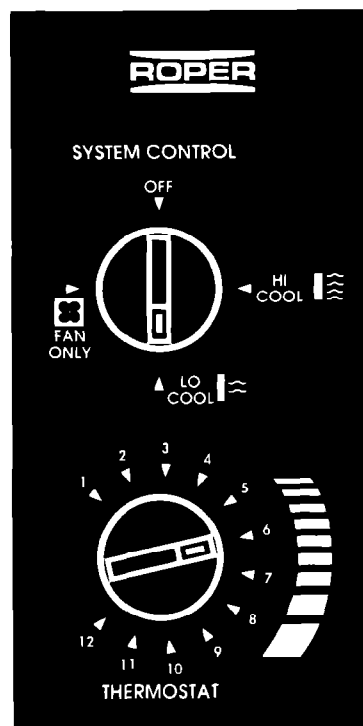

OPERATING YOUR AIR CONDITIONER

Changing air direction

Locate the tab at the top left corner of the grille and move the tab in the direction you want the air to flow (right, left, or straight ahead).

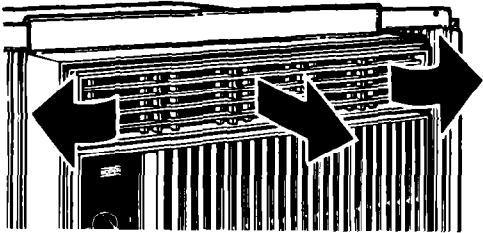

CALL 1-800-447-6737
WITH QUESTIONS OR COMMENTS

Caring For Your Air Conditioner

Proper care of your air conditioner helps ensure longer life of the unit and lower operating costs. Follow these instructions carefully. Call your authorized servicing dealer for an annual checkup.

Cleaning the front panel and air filter

⚠ WARNING



Explosion Hazard
Unplug power cord from outlet before cleaning air conditioner.
Use only nonflammable cleaners.
Failure to follow these instructions can result in death, explosion, fire, or electrical shock.

1. Set System Control to OFF and disconnect power cord from outlet.
2. Remove the front panel from the unit for cleaning. Press down at the top of the front panel to release it from the top of the cabinet.
3. Pull the top of the front panel toward you.
4. Lift front panel up and away from the bottom spring clips.

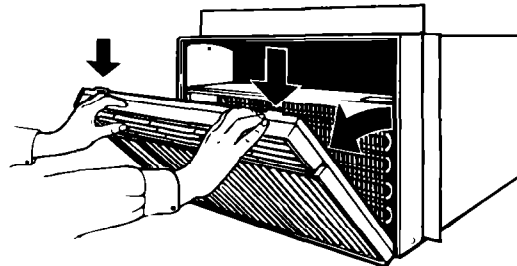

5. Remove filter from back of front panel by removing the elastic band that holds it in place.
6. Clean the filter using a vacuum cleaner. If filter is very dirty, wash it in warm water and mild detergent. Air dry filter thoroughly before replacing it. **Do not use a hot air dryer on the air filter.**

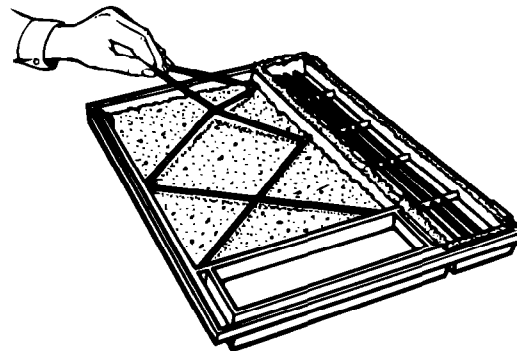

continued on next page 7

CARING FOR YOUR AIR CONDITIONER

7. Clean the front panel with a soft cloth, warm water, and a mild detergent. Rinse and dry thoroughly.
8. Replace air filter in front panel and replace the elastic band.
9. Wipe the control panel clean with a soft, dry cloth.
10. Replace the front panel. Set bottom of front panel on bottom spring clips. Then press down on top edge of front panel and push it onto unit until the tabs snap into place.
11. Reconnect power cord to outlet.

Performing annual maintenance

Your air conditioner needs annual maintenance to ensure steady, top performance throughout the year. Call the service company recommended by your dealer to:

- Inspect and clean the coils and condensate water passages.
- Check fan.

The compressor and fan motor are sealed and need no oiling. The expense of an annual inspection is the consumer's responsibility.

OR

If you are familiar with electrical appliances, you can do the inspection and maintenance yourself. If you choose to do so, follow these steps:

1. Set System Control to OFF and disconnect air conditioner from power supply.
2. Remove air conditioner from window.
3. Press down on the top edge of the front panel until it releases from the cabinet. Pull front panel toward you. Lift up and away from bottom spring clips.

⚠ WARNING



Electrical Shock Hazard

Unplug power cord from outlet before servicing.

Be sure no liquid gets into the motor, electrical control box, or compressor terminals.

Failure to follow these instructions can result in death, electrical shock, or serious injury.

⚠ WARNING

Excessive Weight Hazard

Use 2 or more people to move and install air conditioner.

Failure to do so can result in back or other injury.

CALL 1-800-447-6737
WITH QUESTIONS OR COMMENTS

CARING FOR YOUR AIR CONDITIONER

- Slide curtains out to their fullest width. From the back side, remove the Phillips-head screws (A) holding the curtains to the cabinet.
- Remove the slotted hex-head screws (B) holding the top channel.
- Remove the slotted hex-head screws (C) on the sides of the cabinet.
- Holding both sides of the cabinet, carefully lift the cabinet off the base. Watch out for the sharp metal fins on the front and rear coils.
- Wrap the motor, electrical control box, and the compressor terminal box in plastic film to make sure no water or other liquid gets inside. Water or other liquids could damage the insulation and cause serious mechanical problems.
- Clean and hose out the base, coils, and condensate pans. Clean at least once a year, or more often if the condenser coils and pans collect dirt, sand, leaves, insects, or algae. Also, clean if you detect an odor coming from the air conditioner. Do not use the water collected in the air conditioner for drinking purposes. It is not sanitary.
- Remove plastic film from motor and electrical parts.
- Replace unit in the cabinet. Reattach top channel and side curtains.
- Reinstall unit in the window.
- Replace the front panel.
- Plug in the power cord.

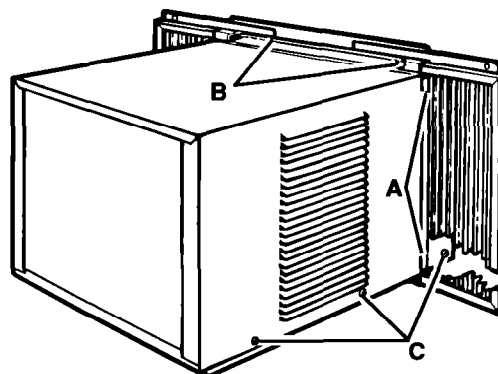

NOTE: It is a good idea to wait 24 hours before starting the unit again. This allows time for all areas to dry thoroughly. The water from rainfall or from normal operation does not harm the components.

Saving energy

- Improve your home's insulation. Seal all doors and windows. Close the fireplace flue.
- Close blinds or drapes on the sunny side of the house. Add window awnings.
- Keep the air filter clean.
- Do not block the airflow from the air conditioner with drapes or furniture.
- Ventilate the attic. High temperatures in the attic add to the cooling load.
- Try not to use heat-producing appliances during the hottest part of the day.
- Turn lights and appliances off when not needed.
- Keep heat registers and cool-air returns closed.
- Use exhaust venting fans while cooking, doing laundry, or bathing.

Troubleshooting

Listed in the chart below are the most common problems consumers run into with their air conditioners. Please read through this chart before calling for service. It could save you the cost of a service call.

PROBLEM	CHECK THE FOLLOWING
Air conditioner won't run	<p>Is the unit plugged into a live circuit with proper voltage?</p> <p>Has the time-delay fuse blown or circuit breaker tripped?</p> <p>Is the System Control set to OFF?</p> <p>Is the Thermostat Control set correctly?</p> <p>Has the local power failed?</p>
Unit blows fuses or trips circuit breaker	<p>Are time-delay fuses being used?</p> <p>Is an extension cord being used? Do not use an extension cord with this or any other appliance.</p> <p>Are you waiting three minutes before trying to restart the unit?</p>
Unit turns on and off OR does not cool the room	<p>Is the air filter clean?</p> <p>Are the coils clean (both inside evaporator and outside condenser)?</p> <p>Is the System Control set too low?</p> <p>Is the Thermostat Control set too low?</p>

Normal operating sounds

When your air conditioner operates normally, you will hear sounds such as:

- Pinging or clicking as water droplets hit the condenser. Water droplets help cool the condenser.
- Air movement from the fan, especially on HI COOL setting.
- Clicks from the cooling cycle.

Sounds may also be caused by house construction – such as vibration of the unit due to wall construction or an unsteady window mounting area.

CALL 1-800-447-6737
WITH QUESTIONS OR COMMENTS

Requesting Assistance or Service

Before calling for assistance or service, please check "Troubleshooting" on page 10. It may save you the cost of a service call. If you still need help, follow the instructions below.

1. If you need assistance* ...

Call our toll-free telephone number.



Dial free from anywhere in the U.S.A.:

1-800-44-ROPER
(1-800-447-6737)

and talk with one of our trained consultants. The consultant can instruct you in how to obtain satisfactory operation from your appliance or, if service is necessary, recommend a qualified service company in your area.

If you prefer, write to:

Mr. William Clark
Consumer Assistance Representative
Whirlpool Corporation
2000 North M-63
Benton Harbor, MI 49022-2692

Please include a daytime phone number in your correspondence.

2. If you need service* ...

Contact the dealer from whom you purchased the appliance or the authorized servicer in your area. For help finding an authorized servicer in your area, call our toll-free number in Step 1.



3. If you need FSP® replacement parts ...

FSP is a registered trademark of Whirlpool Corporation for quality parts. Look for this symbol of quality whenever you need a replacement part for your ROPER® appliance. FSP replacement parts will fit right and work right, because they are made to the same exacting specifications used to build every new ROPER appliance.

To locate FSP replacement parts in your area, refer to Step 2 or call our toll-free telephone number in Step 1.

4. If you are not satisfied with how the problem was solved ...

- Contact the Major Appliance Consumer Action Program (MACAP). MACAP is a group of independent consumer experts that voices consumer views at the highest levels of the major appliance industry.
- Contact MACAP only when the dealer, authorized servicer, and Whirlpool have failed to resolve your problem.

Major Appliance Consumer Action Program
20 North Wacker Drive
Chicago, IL 60606

- MACAP will in turn inform us of your action.

* When asking for help or service:

Please provide a detailed description of the problem, your appliance's complete model and serial numbers, and the purchase date. (See page 2.) This information will help us respond properly to your request.

Index

This index is alphabetical. Look for the word or phrase you are interested in, then look for the page number.

TOPIC	PAGE
AIRFLOW	
Directing	6
CLEANING	
Air filter	7
Front panel	7
FEATURES/PARTS	4
MAINTENANCE	
Annual, performing	8
PARTS/FEATURES	4
SAFETY	3
SERVICE	
Parts	11
Requesting	11
STARTING AIR CONDITIONER	5
TROUBLESHOOTING	10
WARRANTY	16

ROPER® Room Air Conditioner Warranty

LENGTH OF WARRANTY	WE WILL PAY FOR
FULL ONE-YEAR WARRANTY (from date of purchase)	FSP® replacement parts and repair labor to correct defects in materials or workmanship. Service must be provided by an authorized Roper service company.
FULL FIVE-YEAR WARRANTY (from date of purchase)	FSP replacement parts and repair labor for the sealed air conditioner system (compressor, evaporator, condenser, drier or connecting tubing) which we find to be defective in materials or workmanship. Service must be provided by an authorized Roper service company.
WE WILL NOT PAY FOR	
<p>A. Service calls to:</p> <ol style="list-style-type: none"> 1. Correct the installation of your air conditioner. 2. Instruct you how to use your air conditioner. 3. Replace house fuses or correct house wiring. <p>B. Repairs when your air conditioner is used in other than normal, single-family household use.</p> <p>C. Pickup and delivery. Your air conditioner is designed to be repaired in the home.</p> <p>D. Damage to your air conditioner caused by accident, misuse, fire, flood, acts of God, or use of products not approved by us.</p> <p>E. Repairs to parts or systems caused by unauthorized modifications made to the appliance.</p>	

6/94

This ROPER appliance is warranted by Whirlpool Corporation. Under no circumstances shall it be liable under this warranty for incidental or consequential damages. Some states do not allow the exclusion or limitation of incidental or consequential damages, so this exclusion or limitation may not apply to you. This warranty gives you specific legal rights, and you may also have other rights which vary from state to state.

Outside the United States, a different warranty may apply. For details, please contact your authorized Roper dealer.

If you need service, first see the "Troubleshooting" section of this book. After checking "Troubleshooting," additional help can be found by checking the "Requesting Assistance or Service" section, or by calling our toll-free telephone number, **1-800-44-ROPER (1-800-447-6737)**, from anywhere in the U.S.A.